

STM32F103VET6

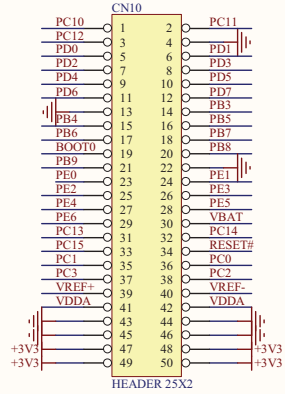

WAKEUP
PA1
PA2
PA3
DAC0
SPI1_SCK
SPI1_MISO
SPI1_MOSI
MicroSDCard_CS
USART1_TX
USART1_RX
USB_DM
USB_DP
TMS/SWDIO
TCK/SWCLK
TDI

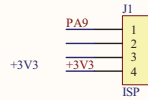
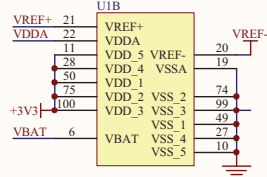
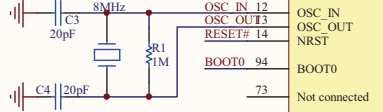
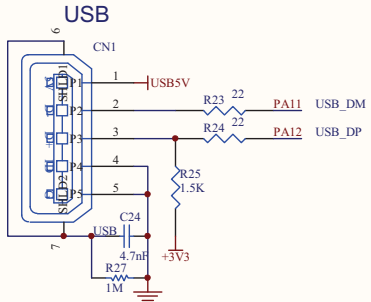
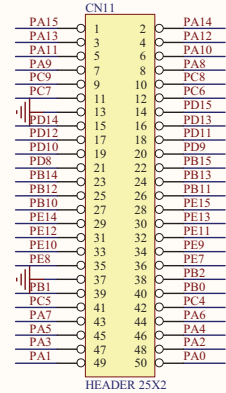
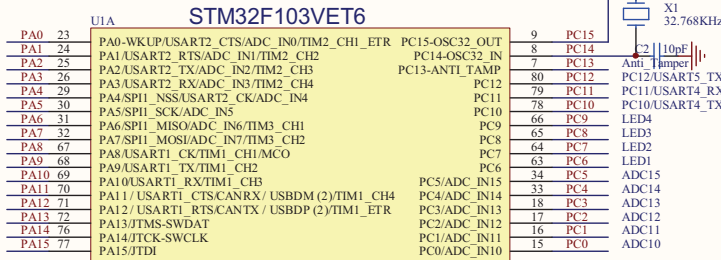

Power regulator

